



**WOOD CATALOGUE**  
2022/2023





C O M P A N Y

## SOLUTIONS D'ÉCLAIRAGE INNOVANTES EN BOIS ET AUTRES MATÉRIAUX NATURELS

Attirez davantage l'attention grâce à la différenciation et obtenez un réel avantage concurrentiel

Offrez à vos clients une expérience d'éclairage unique même si la lumière est éteinte. Les luminaires composés de matériaux naturels, parfaitement équilibrés avec l'environnement en termes de design et de fonction, inspirent chaque jour du neuf. De cette façon, vous augmentez votre visibilité en faisant ressortir votre projet de la foule et en attirant des clients enthousiastes.

Utilisez la puissance de la nature et des systèmes de contrôle intelligents pour plus de santé, de bien-être et de confort  
Inspirez avec des matériaux naturels uniques et une liberté de conception incroyable, qui seront associés à vous et à votre entreprise longtemps après l'installation. Ainsi vos projets généreront automatiquement de nouvelles demandes.

Économisez du temps et des coûts précieux grâce à un soutien professionnel dans la planification et la mise en œuvre

Bénéficiez de nos nombreuses années d'expérience dans le domaine de la technologie d'éclairage, des systèmes de contrôles intelligents et de notre connaissance approfondie du développement LED. Obtenez des visualisations et des modèles 3D convaincants pour une intégration facile dans vos propres projets.

Nous sommes impatients de réaliser des projets uniques en coopération avec vous!

MANUFACTURE FOR WOOD, METAL AND LIGHT





### WOOD LINEAR LED 60 2R

Wood Linear LED 2R is a minimalistic wood luminaire with integrated LED driver. The optical system can be equipped with innovative dark light reflectors or with milled light chambers in different designs. The length can be customized to realize continuous line system.

Surface treatments: Natural, oiled, antibacterial coating with silver nano-particles (flame retardant according to DIN 4102 B1)

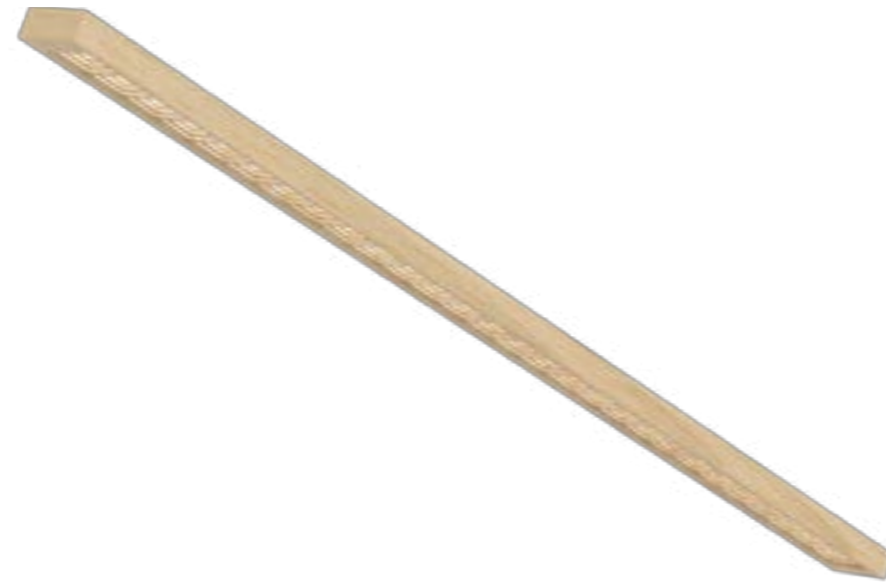

### WOOD LINEAR LED 60 PURE

Wood Linear LED 60 PURE is a minimalistic wood luminaire with a width of just 60mm and a height of 28mm. The optical systems combine lenses with milled light chambers. Since the light emitting surface is continuous, the driver need to be placed on or inside the ceiling.

Surface treatments: Natural, oiled, antibacterial coating with silver nano-particles (flame retardant according to DIN 4102 B1)



### WOOD LINEAR 70 LED

Wood Linear LED 70 is a direct and indirect emitting LED luminaire with integrated LED driver. The optical system can be equipped with innovative dark light reflectors or with milled light chambers in different designs. The very wide indirect light distribution provides a soft ceiling illumination.

Surface treatments: Natural, oiled, antibacterial coating with silver nano-particles (flame retardant according to DIN 4102 B1)



### WOOD LINEAR 60 LED TWIN ROUND

Wood Linear 60 LED Twin Round is a stylish luminaire with integrated LED driver. The optical system can be equipped with innovative dark light reflectors or with milled light chambers in different designs. The shape is perfectly suitable for acoustic absorber integration or natural materials.

Surface treatments: Natural, oiled, antibacterial coating with silver nano-particles (flame retardant according to DIN 4102 B1)





### **WOOD SQUARE LED 60-600**

Wood Square LED 60 is a direct or direct/indirect emitting LED luminaire in square shape. The driver is placed on or inside the ceiling. The optical system can be equipped with innovative dark light reflectors or with milled light chambers in different designs. The shape is ideal for integration of acoustic absorber or natural material fill-ins.

Surface treatments: Natural, oiled, antibacterial coating with silver nano-particles (flame retardant according to DIN 4102 B1)



### **WOOD RING LED 70-1200**

Wood Ring LED 70 is a round LED luminaire. The optical system is based on lenses, positioned around the circle. The LED driver is integrated. The shape is ideal for integration of acoustic absorber or natural material fill-ins.

Surface treatments: Natural, oiled, antibacterial coating with silver nano-particles (flame retardant according to DIN 4102 B1)





### **WOOD TRIANGLE LED**

Wood Triangle LED is the perfect luminaire for night illumination usually mounted above the doors. The length can be customized. Another application is the use as wall luminaire with indirect light distribution. The driver is integrated.

Surface treatments: Natural, oiled, antibacterial coating with silver nano-particles (flame retardant according to DIN 4102 B1)



### **WOOD FREESTANDING LED**

Wood Freestanding LED is one of the view freestanding luminaire based on solid wood. The indirect light distribution is very wide. The optical system can be equipped with innovative dark light reflectors or with milled light chambers in different designs. The integrated daylight and movement sensor provides best energy efficiency characteristics.

Surface treatments: Natural, oiled, antibacterial coating with silver nano-particles (flame retardant according to DIN 4102 B1)





# L I N E A R 6 0 2 R



## PRODUCT DATA

**Size :** 1170 x 60 x 28 mm  
**Weight :** 1,2 kg  
**Materials :** Housing : Natural solid wood  
 Optic: Polycarbonate lens + reflector  
 Base plate: Aluminium  
**Optic :** Dark Light Reflector 80°  
**Light distribution :** Direct  
**Driver :** FIX, DALI, Bluetooth (build in)  
**Ambient temperature :** 0 / + 35 °C  
**Lifetime :** L80B10 - 60 000 hours  
**Installation :** suspended

## WOOD LINEAR LED 60 2R



### WOOD OPTIONS

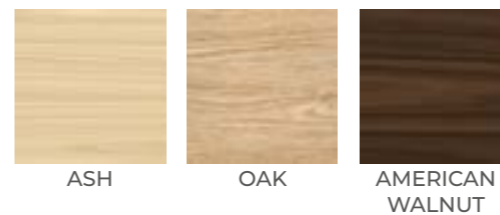

## TECHNICAL SPECIFICATION

CODE	POWER	CRI	CCT	LUMEN
WL602R	27 W	> 90	3000 K	3480 lm
WL602R	27 W	> 90	4000 K	3630 lm
WL602R	28 W	> 90	TW (2700 - 6500 K)	3480 lm

### Order example:

WL602R	-	Power	-	CRI / CCT	-	Beam	-	Wood	-	Driver	-	Option
WL602R	-	27	-	930	-	80	-	OAK	-	FIX	-	XYZ



# L I N E A R P U R E



## PRODUCT DATA

**Size :** 1170 x 60 x 25 mm  
**Weight :** 1,3 kg  
**Materials :** Housing : Natural solid wood  
 Optic: Polycarbonate lens  
 Base plate: Aluminium  
**Optic :** Lens and milled optic chamber 80°  
**Light distribution :** Direct  
**Driver :** FIX, DALI, Bluetooth (inside or on ceiling)  
**Ambient temperature :** 0 / + 35 °C  
**Lifetime :** L80B10 - 60 000 hours  
**Installation :** suspended

## WOOD LINEAR LED 60 PURE

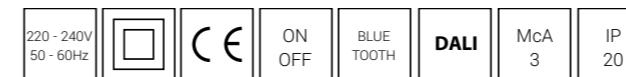

### WOOD OPTIONS

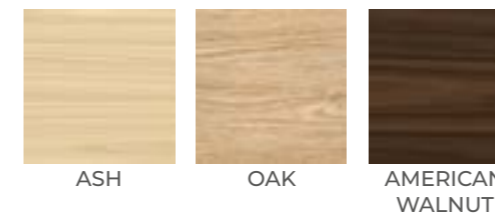

## TECHNICAL SPECIFICATION

CODE	POWER	CRI	CCT	LUMEN
WL60P	27 W	> 90	3000 K	3480 lm
WL60P	27 W	> 90	4000 K	3630 lm
WL60P	28 W	> 90	TW (2700 - 6500 K)	3480 lm

### Order example:

WL60P	-	Power	-	CRI / CCT	-	Beam	-	Wood	-	Driver	-	Option
WL60P	-	27	-	930	-	80	-	OAK	-	FIX	-	XYZ





# LINEAR 70



## PRODUCT DATA

**Size :** 1170 x 70 x 45 mm  
**Weight :** 1,9 kg  
**Materials :** Housing : Natural solid wood  
 Optic: Polycarbonate lens + reflector  
 Back plate: Aluminium  
**Optic :** Dark Light Reflector 80°  
**Light distribution :** Direct 66 % , Indirect 34 %  
**Driver :** FIX, DALI, Bluetooth (build in)  
**Ambient temperature :** 0 / + 35 °C  
**Lifetime :** L80B10 - 60 000 hours  
**Installation :** suspended

## WOOD LINEAR 70 LED

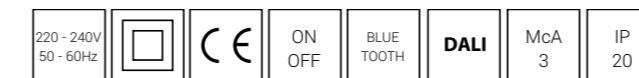

### WOOD OPTIONS

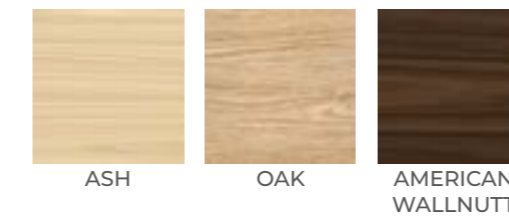

## TECHNICAL SPECIFICATION

CODE	POWER	CRI	CCT	LUMEN
WL70DI	32 W	> 90	3000 K	4060 lm
WL70DI	32 W	> 90	4000 K	4230 lm
WL70DI	33 W	> 90	TW (2700 - 6500 K)	3870 lm

### Order example:

WL70DI	-	Power	-	CRI / CCT	-	Beam	-	Wood	-	Driver	-	Option
WL70DI	-	32	-	930	-	80	-	OAK	-	FIX	-	XYZ



# TWIN ROUND

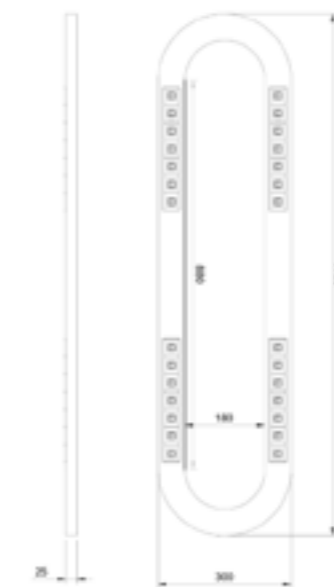

## PRODUCT DATA

**Size :** 1180 x 300 x 25 mm  
**Weight :** 3,6 kg  
**Materials :** Housing : Natural solid wood  
 Optic: Polycarbonate lens + reflector  
 Back plate: Aluminium  
**Optic :** Dark Light Reflector 80°  
**Light distribution :** Direct  
**Driver :** FIX, DALI, Bluetooth (build in)  
**Ambient temperature :** 0 / + 35 °C  
**Lifetime :** L80B10 - 60 000 hours  
**Installation :** suspended

## WOOD LINEAR 60 LED TWIN ROUND

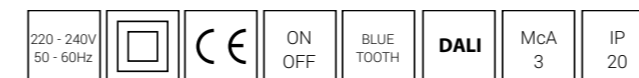

### WOOD OPTIONS

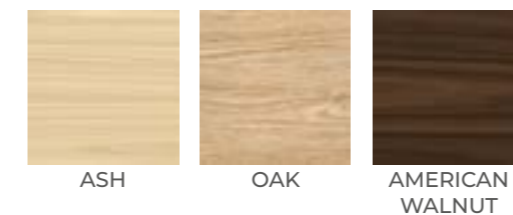

## TECHNICAL SPECIFICATION

CODE	POWER	CRI	CCT	LUMEN
WL60TR	27 W	> 90	3000 K	3480 lm
WL60TR	27 W	> 90	4000 K	3630 lm
WL60TR	28 W	> 90	TW (2700 - 6500 K)	3480 lm

### Order example:

WL60TR	-	Power	-	CRI / CCT	-	Beam	-	Wood	-	Driver	-	Option
WL60TR	-	27	-	930	-	80	-	OAK	-	FIX	-	XYZ



# S Q U A R E

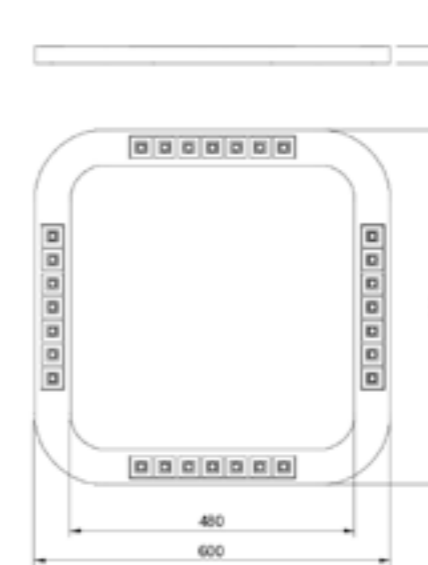

## PRODUCT DATA

**Size :** 600 x 600 x 28 mm  
**Weight :** 2 kg  
**Materials :** Housing : Natural solid wood  
 Optic: Polycarbonate lens + reflector  
 Back plate:: Aluminium  
**Optic :** Dark Light Reflector 80°  
**Light distribution :** Direct  
**Driver :** FIX, DALI, Bluetooth (inside or on ceiling)  
**Ambient temperature :** 0 / + 35 °C  
**Lifetime :** L80B10 - 60 000 hours  
**Installation :** suspended

## WOOD SQUARE 60-600 LED



### WOOD OPTIONS

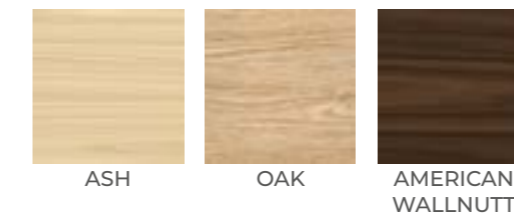

## TECHNICAL SPECIFICATION

CODE	POWER	CRI	CCT	LUMEN
WS60-600	27 W	> 90	3000 K	3480 lm
WS60-600	27 W	> 90	4000 K	3630 lm
WS60-600	28 W	> 90	TW (2700 - 6500 K)	3480 lm

### Order example:

WS60-600	-	Power	-	CRI / CCT	-	Beam	-	Wood	-	Driver	-	Option
WS60-600	-	27	-	930	-	80	-	OAK	-	FIX	-	XYZ



# R I N G

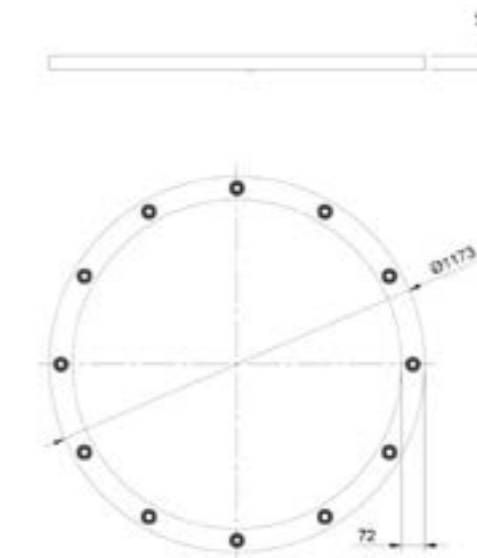

## PRODUCT DATA

**Size :** 1173 x 1173 x 45 mm  
**Weight :** 6,2 kg  
**Materials :** Housing : Natural solid wood  
 Optic: Polycarbonate lens  
 Base plate: Aluminium  
**Optic :** Lens 36°, 60° and milled light chambers  
**Light distribution :** Direct  
**Driver :** FIX, DALI, Bluetooth (build in)  
**Ambient temperature :** 0 / + 35 °C  
**Lifetime :** L80B10 - 60 000 hours  
**Installation :** suspended

## WOOD RING LED 70-1200

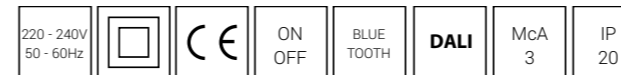

### WOOD OPTIONS

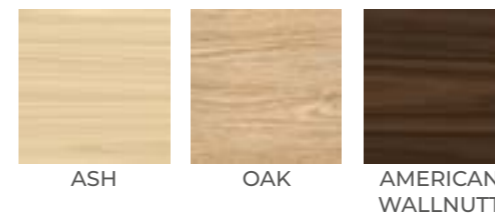

## TECHNICAL SPECIFICATION

CODE	POWER	CRI	CCT	LUMEN
WRI70-1200	70 W	> 90	3000 K	7800 lm
WRI70-1200	70 W	> 90	4000K	8000 lm

### Order example:

WRI70-1200	-	Power	-	CRI / CCT	-	Beam	-	Wood	-	Driver	-	Option
WRI70-1200	-	70	-	930	-	60	-	OAK	-	FIX	-	XYZ



# TRIANGLE



## PRODUCT DATA

**Size :** 990 x 185 x 65 mm  
**Weight :** 1,8 kg  
**Materials :** Housing : Natural solid wood  
 Optic: PMMA diffusor  
 Back plate:: Aluminium  
**Optic :** PMMA diffusor  
**Light distribution :** Direct  
**Driver :** FIX, DALI, Bluetooth (build in)  
**Ambient temperature :** 0 / + 35 °C  
**Lifetime :** L80B10 - 60 000 hours  
**Installation :** surface mounted (wall)

## WOOD TRIANGLE LED



### WOOD OPTIONS

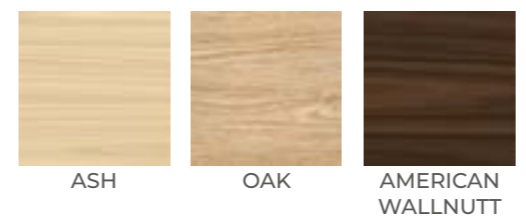

## TECHNICAL SPECIFICATION

CODE	POWER	CRI	CCT	LUMEN
WT	24 W	> 90	3000 K	1800 lm
WT	24 W	> 90	4000 K	1890 lm
WT	24 W	> 90	TW (2700 - 6500 K)	1800 lm

### Order example:

WT	-	Power	-	CRI / CCT	-	Beam	-	Wood	-	Driver	-	Option
WT	-	24	-	930	-	DIFF	-	ASH	-	FIX	-	XYZ



# F R E E S T A N D I N G

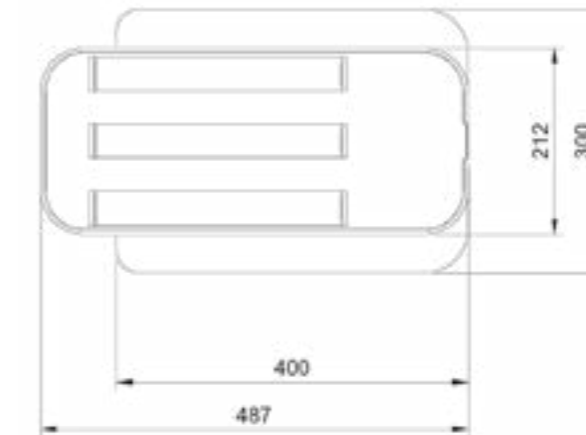

## PRODUCT DATA

**Size :** 487 x 212 x 1900 mm  
**Weight :** 6,8 kg  
**Materials:** Housing : Natural solid wood  
 Reflector: Polycarbonate lens + reflector  
 Base plate: Aluminium  
**Optic :** Dark Light Reflector 80 °  
**Light distribution :** Direct 40 % , Indirect 60 %  
**Driver :** FIX, DALI, Bluetooth (build in)  
**Sensor :** Daylight and movement  
**Ambient temperature :** 0 / + 35 °C  
**Lifetime :** L80B10 - 60 000 hours  
**Installation :** freestanding

## WOOD FREESTANDING LED



### WOOD OPTIONS

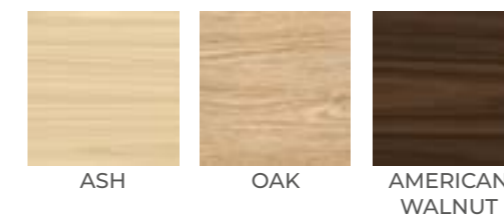

## TECHNICAL SPECIFICATION

CODE	POWER	CRI	CCT	LUMEN
WFS	68 W	> 90	3000 K	7600 lm
WFS	68 W	> 90	4000 K	8000 lm
WFS	68 W	> 90	TW (2700 - 6500 K)	7600 lm

### Order example:

WFS	-	Power	-	CRI / CCT	-	Beam	-	Wood	-	Driver	-	Option
WFS	-	45	-	930	-	80	-	OAK	-	FIX	-	XYZ





**WOOD ROUND LED 600x110  
DIFFUSE**

Wood Round LED 600 is a direct or direct / indirect emitting LED luminaire with integrated LED driver. The optical system is featured by a satinated diffusor. The wood patterns are vertical around the diameter. The solid segmented bottom ring has horizontal wood patterns.

Surface threathments: Natural, oiled, antibacterial coating with silver nano-particles (flame retardant according to DIN 4102 B1)



**WOOD ROUND LED 850x110  
DIFFUSE**

Wood Round LED 850 is a direct or direct / indirect emitting LED luminaire with integrated LED driver. The optical system is featured by a satinated diffusor. The wood patterns are vertical around the diameter. The solid segmented bottom ring has horizontal wood patterns.

Surface threathments: Natural, oiled, antibacterial coating with silver nano-particles (flame retardant according to DIN 4102 B1)



**WOOD ROUND LED 1100x110  
DIFFUSE**

Wood Round LED 1100 is a direct or direct / indirect emitting LED luminaire with integrated LED driver. The optical system is featured by a satinated diffusor. The wood patterns are vertical around the diameter. The solid segmented bottom ring has horizontal wood patterns.

Surface threathments: Natural, oiled, antibacterial coating with silver nano-particles (flame retardant according to DIN 4102 B1)







### WOOD ROUND LED 600x300 DIFFUSE

Wood Round LED 600 is a direct or direct / indirect emitting LED luminaire with integrated LED driver. The optical system is featured by a satinated diffusor. The wood patterns are vertical around the diameter. The solid segmented bottom ring has horizontal wood patterns.

Surface threathments: Natural, oiled, antibacterial coating with silver nano-particles (flame retardant according to DIN 4102 B1)



### WOOD ROUND LED 850x300 DIFFUSE

Wood Round LED 850 is a direct or direct / indirect emitting LED luminaire with integrated LED driver. The optical system is featured by a satinated diffusor. The wood patterns are vertical around the diameter. The solid segmented bottom ring has horizontal wood patterns.

Surface threathments: Natural, oiled, antibacterial coating with silver nano-particles (flame retardant according to DIN 4102 B1)



### WOOD ROUND LED 1100x300 DIFFUSE

Wood Round LED 1100 is a direct or direct / indirect emitting LED luminaire with integrated LED driver. The optical system is featured by a satinated diffusor. The wood patterns are vertical around the diameter. The solid segmented bottom ring has horizontal wood patterns.

Surface threathments: Natural, oiled, antibacterial coating with silver nano-particles (flame retardant according to DIN 4102 B1)



### WOOD DOWNLIGHT SQUARE DIFFUSE

Wood Downlight Square is a downlight in square shape. The optical systems is based on a satinated diffusor. On vertical services is a decorative lightline. The aura effect is brightening the ceiling.

Surface threathments: Natural, oiled, antibacterial coating with silver nano-particles (flame retardant according to DIN 4102 B1)



### WOOD LINEAR 50 LED DIFFUSE

Wood Linear 50 LED is a luminaire with a satinated optical system. The illumination is direct or direct / indirect.

Surface threathments: Natural, oiled, antibacterial coating with silver nano-particles (flame retardant according to DIN 4102 B1)



### WOOD ROUND LED 400x700 DIFFUSE

Wood Round LED 400 is a direct or direct / indirect emitting LED luminaire with integrated LED driver. The optical system is featured by a satinated diffusor. The wood patterns are vertical around the diameter. The solid segmented bottom ring has horizontal wood patterns.

Surface threathments: Natural, oiled, antibacterial coating with silver nano-particles (flame retardant according to DIN 4102 B1)





# D O W N L I G H T S Q U A R E



## PRODUCT DATA

**Size :** 301 x 301 x 74 mm  
**Weight :** 1,6 kg  
**Materials :** Housing : Natural solid wood  
 Optic: PMMA  
 Backplate: Aluminium  
**Optic :** Diffusor / Microprisma  
**Light distribution :** Direct / Indirect  
**Driver :** FIX, DALI, Bluetooth (build in)  
**Ambient temperature :** 0 / + 35 °C  
**Lifetime :** L80B10 - 60 000 hours  
**Installation :** surface mounted (ceiling, wall)

## WOOD DOWNLIGHT SQUARE DIFFUSE

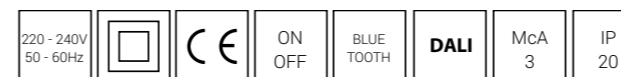

### WOOD OPTIONS

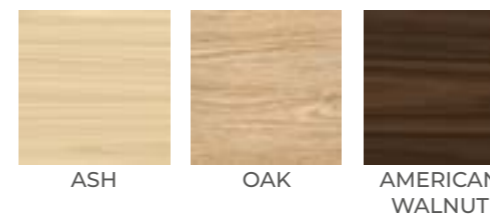

## TECHNICAL SPECIFICATION

CODE	POWER	CRI	CCT	LUMEN
WSD300	18 W	> 90	3000 K	1700 lm
WSD300	18 W	> 90	4000 K	1800 lm
WSD300	18 W	> 90	TW (2700 - 6500 K)	1700 lm

### Order example:

WSD300	-	Power	-	CRI / CCT	-	Beam	-	Wood	-	Driver	-	Option
WSD300	-	18	-	930	-	DIFF	-	ASH	-	FIX	-	XYZ



# L I N E A R 5 0



## PRODUCT DATA

**Size :** 50 x 70 x1050 mm  
**Weight :** 1,5 kg  
**Materials :** Housing : Natural solid wood  
 Optic: PMMA  
 Base plate: Aluminium  
**Optic :** difusor / microprisma  
**Light distribution :** Direct  
**Driver :** FIX, DALI, Bluetooth (inside or on ceiling)  
**Ambient temperature :** 0 / + 35 °C  
**Lifetime :** L80B10 - 60 000 hours  
**Installation :** surface mounted

## WOOD LINEAR 50 DIFFUSE



### WOOD OPTIONS

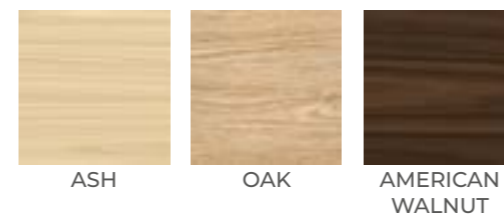

## TECHNICAL SPECIFICATION

CODE	POWER	CRI	CCT	LUMEN
WL50DIFF	27 W	> 90	3000 K	2700 lm
WL50DIFF	27 W	> 90	4000 K	2750 lm
WL50DIFF	28 W	> 90	TW (2700 - 6500 K)	2700 lm

### Order example:

WL50DIFF	-	Power	-	CRI / CCT	-	Beam	-	Wood	-	Driver	-	Option
WL50DIFF	-	27	-	930	-	DIFF	-	ASH	-	FIX	-	XYZ



R O U N D 4 0 0 x 7 0 0



## PRODUCT DATA

Size : 395 x 395 x 691 mm  
 Weight : 11,5 kg  
 Materials : Housing : Natural solid wood  
 Optic: PMMA  
 Backplate: Aluminium  
 Optic : Diffusor / Microprisma  
 Light distribution : lambertian  
 Driver : FIX, DALI, Bluetooth (build in)  
 Ambient temperature : 0 / + 35 °C  
 Lifetime : L80B10 - 60 000 hours  
 Installation : surface mounted, suspended

## WOOD ROUND LED 400x700 DIFFUSE



### WOOD OPTIONS

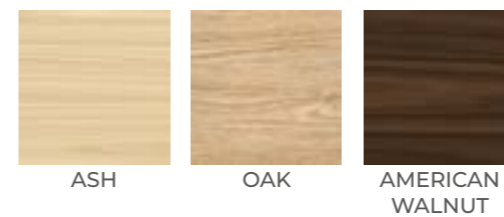

## TECHNICAL SPECIFICATION

CODE	POWER	CRI	CCT	LUMEN
WR400x700MR	84 W	> 90	3000 K	6345 lm
WR400x700MR	84 W	> 90	4000 K	7050 lm

### Order example:

WR400x700MR	-	Power	-	CRI / CCT	-	Beam	-	Wood	-	Driver	-	Option
WR400x700MR	-	84	-	930	-	DIFF	-	OAK	-	FIX	-	XYZ



R O U N D 6 0 0 x 1 1 0

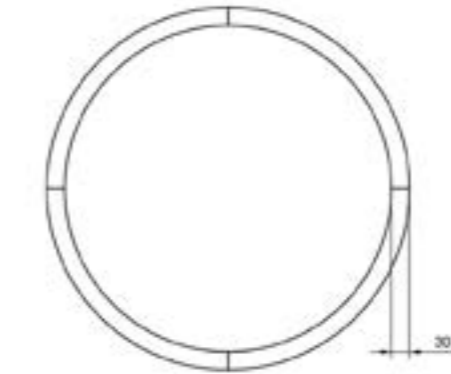

## PRODUCT DATA

Size : 600 x 600 x 110 mm  
 Weight : 4 kg  
 Materials : Housing : Natural solid wood  
 Optic: PMMA  
 Backplate:: Aluminium  
 Optic : Diffusor / Microprisma  
 Light distribution : lambertian  
 Driver : FIX, DALI, Bluetooth (build in)  
 Ambient temperature : 0 / + 35 °C  
 Lifetime : L80B10 - 60 000 hours  
 Installation : surface mounted, suspended

## WOOD ROUND LED 600x110 DIFFUSE

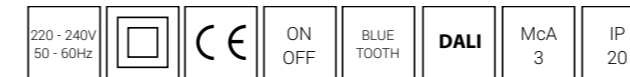

### WOOD OPTIONS

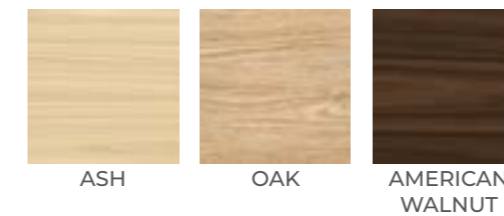

## TECHNICAL SPECIFICATION

CODE	POWER	CRI	CCT	LUMEN
WR600x110MR	76 W	> 90	3000 K	6685 lm
WR600x110MR	76 W	> 90	4000 K	7750lm

### Order example:

WR600x110MR	-	Power	-	CRI / CCT	-	Beam	-	Wood	-	Driver	-	Option
WR600x110MR	-	76	-	930	-	DIFF	-	OAK	-	FIX	-	XYZ



R O U N D 8 5 0 x 1 1 0

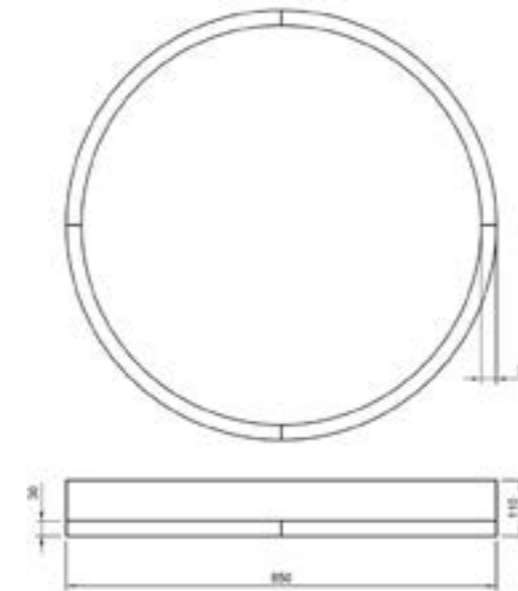

## PRODUCT DATA

**Size :** 850 x 850 x 110 mm  
**Weight :** 10,8 kg  
**Materials :** Housing : Natural solid wood  
 Optic: PMMA  
 Backplate:: Aluminium  
**Optic :** Diffusor / Microprisma  
**Light distribution :** lambertian  
**Driver :** FIX, DALI, Bluetooth (build in)  
**Ambient temperature :** 0 / + 35 °C  
**Lifetime :** L80B10 - 60 000 hours  
**Installation :** surface mounted, suspended

## WOOD ROUND LED 850x110 DIFFUSE



### WOOD OPTIONS

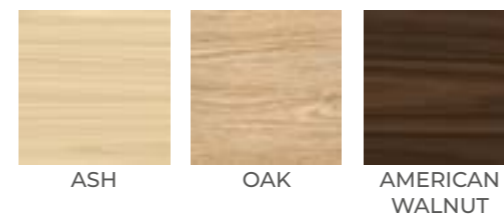

## TECHNICAL SPECIFICATION

CODE	POWER	CRI	CCT	LUMEN
WR850x110MR	109 W	> 90	3000 K	10350 lm
WR850x110MR	109 W	> 90	4000 K	11400lm

### Order example:

WR850x110MR	-	Power	-	CRI / CCT	-	Beam	-	Wood	-	Driver	-	Option
WR850x110MR	-	109	-	930	-	DIFF	-	OAK	-	FIX	-	XYZ



R O U N D 1 1 0 0 x 1 1 0

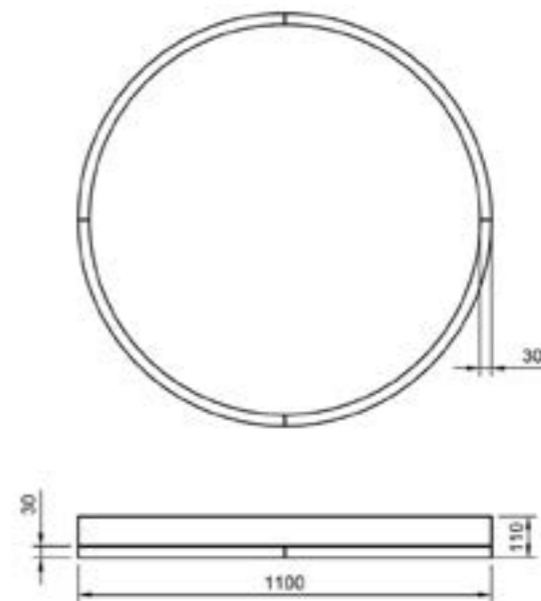

## PRODUCT DATA

Size : 1100 x 1100 x 110 mm  
 Weight : 18,2 kg  
 Materials : Housing : Natural solid wood  
 Optic: PMMA  
 Backplate: Alluminium  
 Optic : Diffusor / Microprisma  
 Light distribution : lambertian  
 Driver : FIX, DALI, Bluetooth (build in)  
 Ambient temperature : 0 / + 35 °C  
 Lifetime : L80B10 - 60 000 hours  
 Installation : surface mounted, suspended

## WOOD ROUND LED 1100x110 DIFFUSE



### WOOD OPTIONS

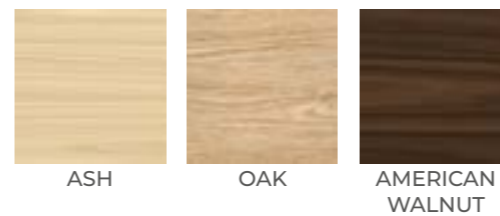

## TECHNICAL SPECIFICATION

CODE	POWER	CRI	CCT	LUMEN
WR1100x110MR	128W	> 90	3000 K	12140 lm
WR1100x110MR	128 W	> 90	4000 K	13400lm

### Order example:

WR850x110MR	-	Power	-	CRI / CCT	-	Beam	-	Wood	-	Driver	-	Option
WR850x110MR	-	109	-	930	-	DIFF	-	OAK	-	FIX	-	XYZ



R O U N D 6 0 0 x 3 0 0

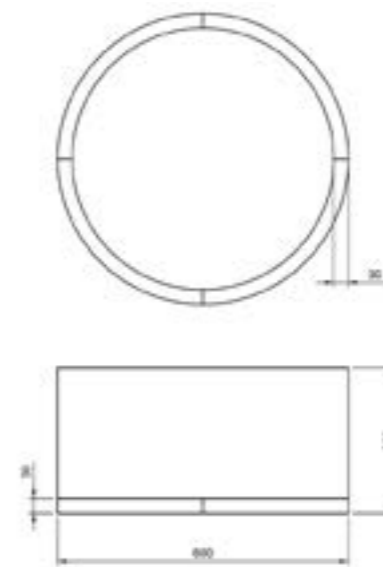

### PRODUCT DATA

Size : 600 x 600 x 300 mm  
 Weight : 4,8 kg  
 Materials : Housing : Natural solid wood  
 Optic: PMMA  
 Backplate: Aluminium  
 Optic : Diffusor / Microprisma  
 Light distribution : lambertian  
 Driver : FIX, DALI, Bluetooth (build in)  
 Ambient temperature : 0 / + 35 °C  
 Lifetime : L80B10 - 60 000 hours  
 Installation : surface mounted, suspended

### WOOD ROUND LED 600x300 DIFFUSE



### WOOD OPTIONS

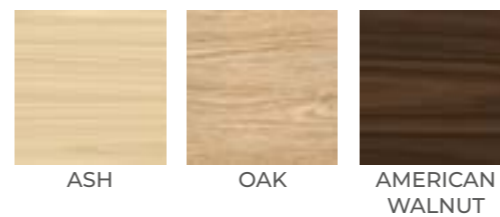

### TECHNICAL SPECIFICATION

CODE	POWER	CRI	CCT	LUMEN
WR600x300MR	76 W	> 90	3000 K	6685 lm
WR600x300MR	76 W	> 90	4000 K	7550 lm

### Order example:

WR600x300MR	-	Power	-	CRI / CCT	-	Beam	-	Wood	-	Driver	-	Option
WR600x300MR	-	76	-	930	-	DIFF	-	OAK	-	FIX	-	XYZ





R O U N D 8 5 0 x 3 0 0

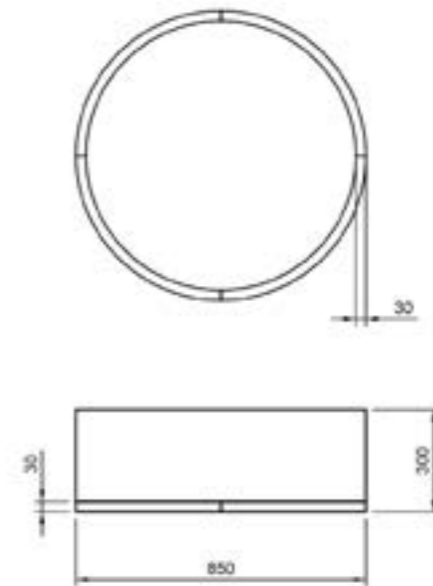

### PRODUCT DATA

Size : 850 x 850 x 300 mm  
 Weight : 13,2 kg  
 Materials : Housing : Natural solid wood  
 Optic: PMMA  
 Backplate: Aluminium  
 Optic : Diffusor / Microprisma  
 Light distribution : lambertian  
 Driver : FIX, DALI, Bluetooth (build in)  
 Ambient temperature : 0 / + 35 °C  
 Lifetime : L80B10 - 60 000 hours  
 Installation : surface mounted, suspended

### WOOD ROUND LED 850x300 DIFFUSE



### WOOD OPTIONS

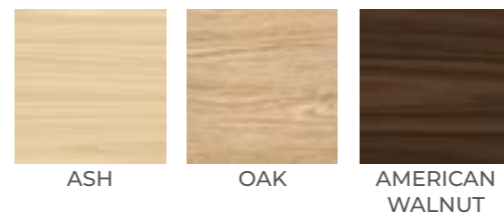

### TECHNICAL SPECIFICATION

CODE	POWER	CRI	CCT	LUMEN
WR850x300MR	109 W	> 90	3000 K	10350 lm
WR850x300MR	109 W	> 90	4000 K	11400 lm

### Order example:

WR850x300MR	-	Power	-	CRI / CCT	-	Beam	-	Wood	-	Driver	-	Option
WR850x300MR	-	109	-	930	-	DIFF	-	OAK	-	FIX	-	XYZ



R O U N D 1 1 0 0 x 3 0 0



### WOOD ROUND LED 1100x300 DIFFUSE



#### WOOD OPTIONS

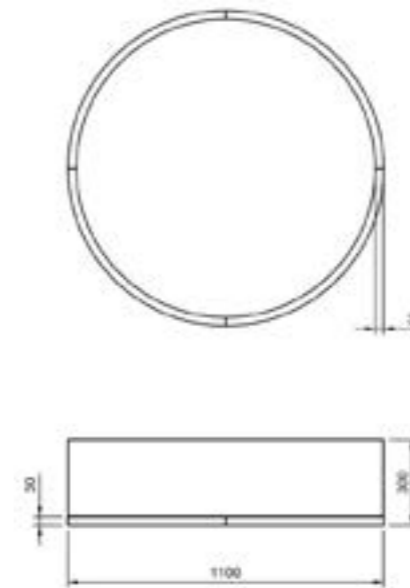
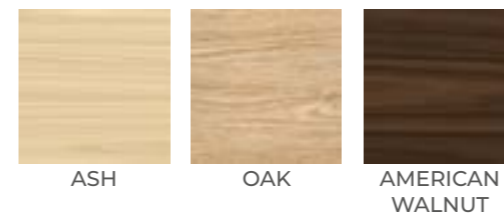

### PRODUCT DATA

Size : 1100 x 1100 x 300 mm  
 Weight : 25 kg  
 Materials : Housing : Natural solid wood  
 Optic: PMMA  
 Backplate: Aluminium  
 Optic : Diffusor / Microprisma  
 Light distribution : lambertian  
 Driver : FIX, DALI, Bluetooth (build in)  
 Ambient temperature : 0 / + 35 °C  
 Lifetime : L80B10 - 60 000 hours  
 Installation : surface mounted, suspended

### TECHNICAL SPECIFICATION

CODE	POWER	CRI	CCT	LUMEN
WR1100x300MR	128 W	> 90	3000 K	12140 lm
WR1100x300MR	128 W	> 90	4000 K	13400 lm

#### Order example:

WR1100x300MR	-	Power	-	CRI / CCT	-	Beam	-	Wood	-	Driver	-	Option
WR1100x300MR	-	128	-	930	-	DIFF	-	OAK	-	FIX	-	XYZ

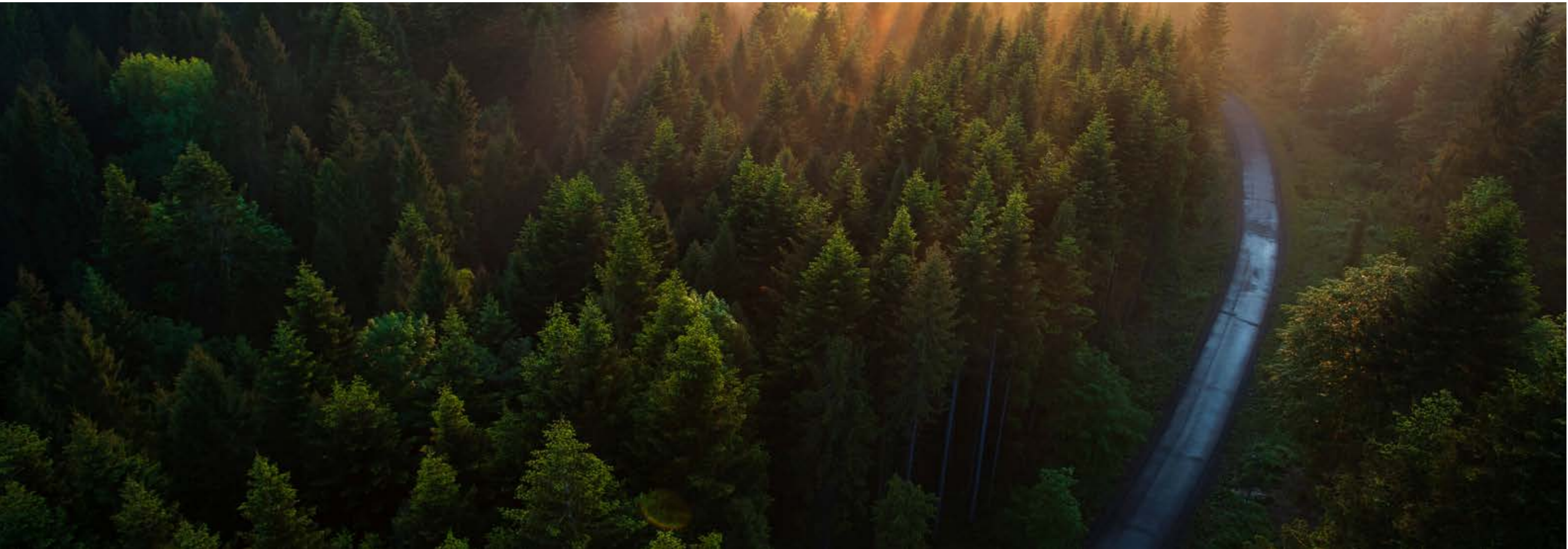



### **WOOD RING DUAL 610**

Wood Ring Dual 610 is a round ring luminaire with direct and indirect illumination. It is a combination of a classic and wood luminaire and combines both worlds. The inside part is made of powder coated Aluminium or real brass, the outside ring is made of solide wood. The advantage of this design series is the wide usage of this piece of art, from rustical till modern design spaces.

Surface threathments: Natural, oiled, antibacterial coating with silver nano-particles (flame retardant according to DIN 4102 B1)



### **WOOD ELLIPSE DUAL**

Wood Elypse Dual is a luminaire in ellipse shape with direct and indirect illumination. It is a combination of a classic and wood luminaire and combines both worlds. The inside part is made of Aluminium with many powder coating color options or even real brass, the outside ellipse is made of solide wood. The advantage of this design series is the wide usage of this piece of art, from rustical to modern design spaces.

Surface threathments: Natural, oiled, antibacterial coating with silver nano-particles (flame retardant according to DIN 4102 B1)





# R I N G D U A L

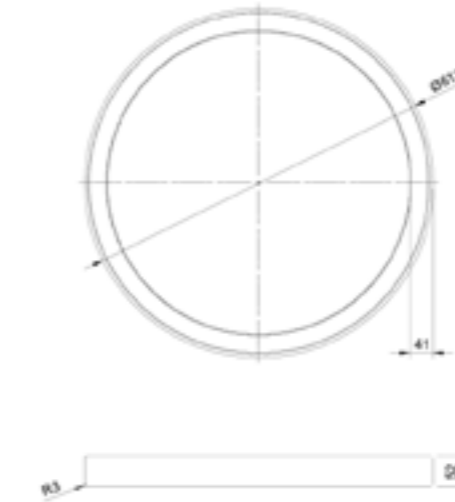

## PRODUCT DATA

**Size :** 613 x 613 x 52 mm  
**Weight :** 6,8 kg  
**Materials :** Housing : Natural solid wood  
 Optic: PMMA  
 Base plate: Aluminium  
**Optic :** Diffusor  
**Light distribution :** Direct 70% , indirect 30%  
**Driver :** FIX, DALI, Bluetooth (inside or on ceiling)  
**Ambient temperature :** 0 / + 35 °C  
**Lifetime :** L80B10 - 60 000 hours  
**Installation :** suspended

## WOOD RING DUAL LED

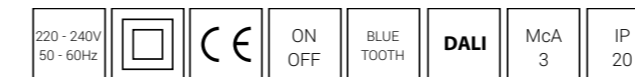

## WOOD OPTIONS

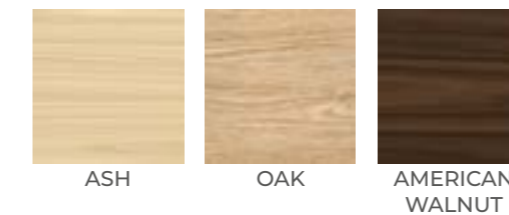

## TECHNICAL SPECIFICATION

CODE	POWER	CRI	CCT	LUMEN
WRI610x52DUAL	51 W	> 90	3000 K	3264 lm
WRI610x52DUAL	51 W	> 90	4000 K	3525 lm
WRI610x52DUAL	51 W	> 90	TW (2700 - 6500 K)	3264 lm

## Order example:

WRI610x52DUAL	-	Power	-	CRI / CCT	-	Beam	-	Wood	-	Driver	-	Option
WRI610x52DUAL	-	51	-	930	-	DIFF	-	OAK	-	FIX	-	XYZ



# E L L I P S E D U A L



## WOOD ELLIPSE DUAL LED



### WOOD OPTIONS

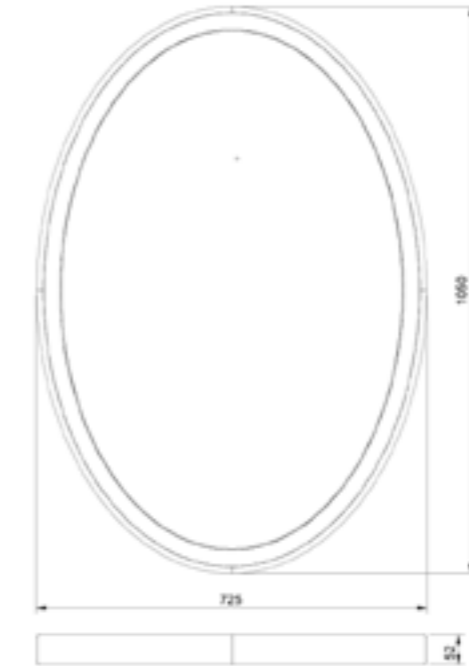
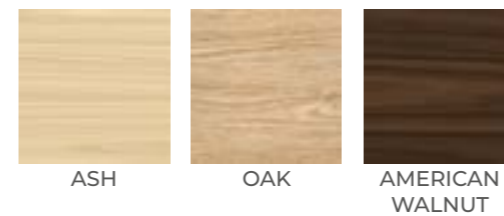

## PRODUCT DATA

**Size :** 725 x 1050 x 52 mm  
**Weight :** 8.6 kg  
**Materials :** Housing : Natural solid Wood  
 Optic: PMMA  
 Base plate: Aluminium  
**Optic :** Lambertian  
**Light distribution :** Direct 50 % , Indirect 50 %  
**Driver :** FIX, DALI, Bluetooth (inside or on ceiling)  
**Ambient temperature :** 0 / + 35 °C  
**Lifetime :** L80B10 - 60 000 hours  
**Installation :** suspended

## TECHNICAL SPECIFICATION

CODE	POWER	CRI	CCT	LUMEN
WELL	92 W	> 90	3000 K	5920 lm
WELL	92 W	> 90	4000 K	6380 lm
WELL	92 W	> 90	TW (2700 - 6500 K)	5920 lm

### Order example:

WELL	-	Power	-	CRI / CCT	-	Beam	-	Wood	-	Driver	-	Option
WELL	-	92	-	930	-	80	-	OAK	-	FIX	-	XYZ





### WOOD microLINE EDGE

Wood microLine EDGE is a 48V based system. The solid wood bodies with share edges embrace the minimalistic rails, so that it gets visually one unit. The systems supports an unbelievable wide design possibility.

Surface treatments: Natural, oiled, antibacterial coating with silver nano-particles (flame retardant according to DIN 4102 B1)



### WOOD microLINE CURVED

Wood microLine CURVED is a 48V based system. The solid wood bodies with nicely curved shape embrace the minimalistic rails, so that it gets visually one unit. The systems supports an unbelievable wide design possibility.

Surface treatments: Natural, oiled, antibacterial coating with silver nano-particles (flame retardant according to DIN 4102 B1)



### COMPONENTS



microRail 1/4 CIRCLE  
300 mm



microRail 1/4 CIRCLE  
500 mm



microRail MIDDLE FEED



microRail END  
FEED



microRail MIDDLE L  
FEED



microRail DRIVER  
100 W





# M I C R O L I N E C U R V E D

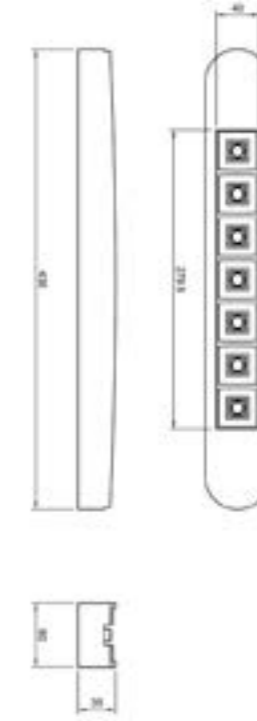

## PRODUCT DATA

**Size :** 60 x 35 x 430 mm  
**Weight :** 0,8 kg  
**Materials :** Housing : Natural solid wood  
 Optic: Polycarbonate lens + reflector  
 Base plate: Aluminium  
**Optic :** Dark Light Reflector 80 °  
**Light distribution :** Direct  
**Driver :** FIX, DALI, Bluetooth ( build in to connector)  
**Ambient temperature :** 0 / + 35 °C  
**Lifetime :** L80B10 - 60 000 hours  
**Installation :** suspended track with click system

## WOOD MICROLINE CURVED

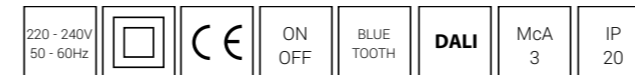

### WOOD OPTIONS

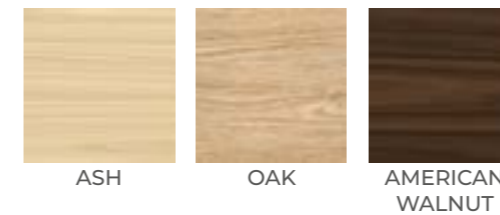

## TECHNICAL SPECIFICATION

CODE	POWER	CRI	CCT	LUMEN
WML-WL60C-7x1	9 W	> 90	3000 K	1160 lm
WML-WL60C-7x1	9 W	> 90	4000 K	1210 lm

### Order example:

WML-WL60C-7x1	-	Power	-	CRI / CCT	-	Beam	-	Wood	-	Driver	-	Option
WML-WL60C-7x1	-	9	-	930	-	80	-	ASH	-	FIX	-	XYZ



# M I C R O L I N E E D G E

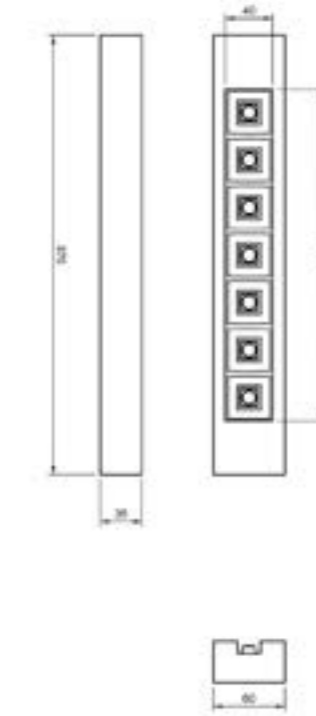

## PRODUCT DATA

**Size :** 60 x 35 x 370 mm  
**Weight :** 0,8 kg  
**Materials :** Housing : Natural solid wood  
 Optic: Polycarbonate lens + reflector  
 Base plate: Aluminium  
**Optic :** Dark Light Reflector 80 °  
**Light distribution :** Direct  
**Driver :** FIX, DALI, Bluetooth (build in to connector)  
**Ambient temperature :** 0 / + 35 °C  
**Lifetime :** L80B10 - 60 000 hours  
**Installation :** suspended track with click system

## WOOD MICROLINE EDGE

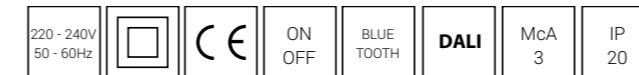

## WOOD OPTIONS

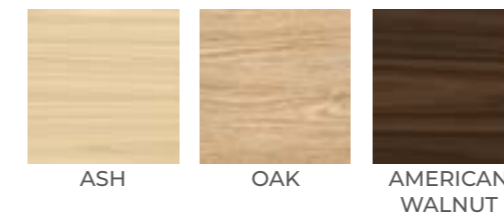

## TECHNICAL SPECIFICATION

CODE	POWER	CRI	CCT	LUMEN
WML-WL60E-7x1	9 W	> 90	3000 K	1160 lm
WML-WL60E-7x1	9 W	> 90	4000 K	1210 lm

## Order example:

WML-WL60E-7x1	-	Power	-	CRI / CCT	-	Beam	-	Wood	-	Driver	-	Option
WML-WL60E-7x1	-	9	-	930	-	80	-	ASH	-	FIX	-	XYZ



**LOOK FEEL & SMELL**



## LOOK, FEEL AND SMELL

Experience the aroma of our natural materials every day, such as the smell of freshly ground coffee, hay, roses, moss and many more. The quality and unmistakable origin of our selected materials also determine the lighting experience. Without the addition of (artificial) fragrances or aromas, our natural materials provide with their natural fragrance good indoor climate.

## FORM FOLLOWS FUNCTION

The term we live by the American sculptor Horatio Greenough was already mentioned in 1852 in connection with the organic principles of architecture by „form follows function“. This means that each individual luminaire focuses on the essentials instead of overloading the viewer or the room.

## PERFECT ROOM CLIMATE

Our natural materials reflect, reveal, and enchant their surroundings, regardless of whether they are switched on or off. The indoor climate also benefits from the sound-absorbing effect of the natural materials. Each lamp is therefore unique, both our series products and the lamps with your very own fingerprint. The masterly and traditional craftsmanship of woodworking is our top priority and allows a unique piece to be created in meticulous detail. The optic arouses the curiosity to run your fingers over the wood type. Feel the origin of the hay from the steep slopes of Tyrol, the flowers from the alpine meadows or the moss wood types with lichen and pieces of bark.

## THE ADVANTAGES AT A GLANCE

### 1 LOOK, FEEL AND SMELL

These are the unique combined properties of this collection. Depending on the application and material, the fragrance lasts between 3 and 10 years. If the scent wears off or you want to change the look , the panels can be reordered and replaced at any time.

### 3 SOUND ABSORBATION

Some natural materials are real performers when it comes to acoustics. By combining different layers of pure natural materials, even absorber class A specifications can be achieved! We also offer our customers additional wall panels that perfectly match the lights in terms of design and shape.

### 5 YOUR OWN DESIGN

As with our solid wood light portfolio, we offer customer-specific designs in the Look Feel and SMELL collection. Due to our manufacturing process consisting of CNC and hand-made finishing, new designs are possible within SIX weeks.

### 2 100% ANTI-ALLERGIC

Thanks to the innovative production process and years of development, our partner has managed to process these natural materials in such a way that they do not cause allergies. This has been confirmed by independent laboratories.

### 4 FLAME RETARDANT

The luminaires are also optionally available in B1 quality and thus correspond to fire protection class DIN 4102-1 for flame-retardant materials. This enables the use in public areas.





## CORNFLOWER

---

THE COLOUR OF THE PETALS OF CORNFLOWER BLUE IS VERY INTENSE



## ROSE

---

The petals of the rose: highly fragrant and colourful. Intensity of colour depending on availability of petals. Slight colour deviations are possible. No artificial colours or fragrant substances added.



## VANILLA

---

The vanilla pods belong to our range of upcycle materials forming the intense smelling natural surface WANILLÄ.



## COFFEE

---

The coffee powder we use is one of our upcycling raw materials. The wonderful aroma is well-known and characteristic.



## MOSS

---

The dark green moss we use is one of our upcycling materials

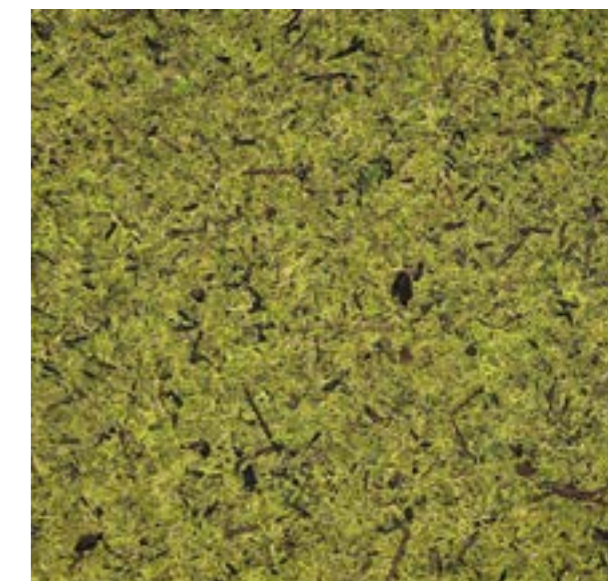

## MOSS LIGHT

---

The light green moss we use is one of our upcycling materials

N A T U R A L M A T E R I A L S

L O O K - F E E L - S M E L L



### HAY & CORNFLOWER

---

The delicately scented organic alpine-hay is discreetly gilded with rose petals which give the natural surface a slightly red tint



### HAY & ROSE

---

The delicately scented organic alpine-hay is discreetly gilded with rose petals which give the natural surface a slightly red tint



### ALPHAY MIX

---

A special mix of alpine-hay, marguerites in various sizes, edelweiss and petals of cornflowers, rose and heather



### LAVENDER

---

Lavender has been known for centuries for its soothing and harmonizing effect. The intense natural scent is a remedy for uneasiness and sleep-onset insomnia

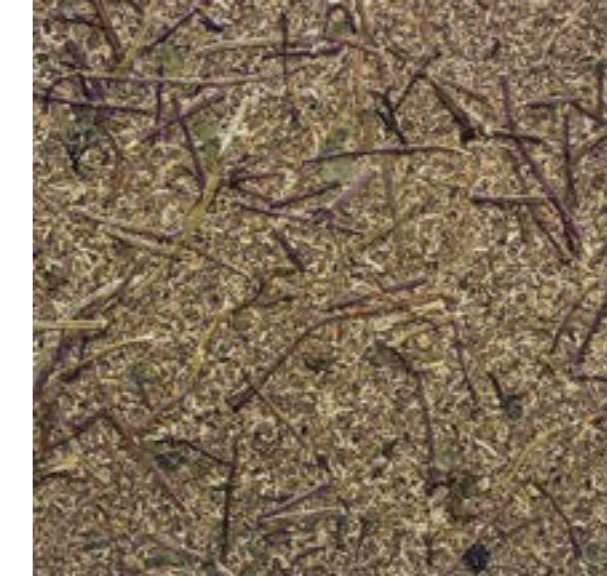

### PEPPERMINT

---

The cooling and refreshing peppermint is one of our upcycling raw materials. In our production we use stems which are not suitable for tea production



### SUNFLOWERS

---

The husks of sunflower seeds are one of our upcycling raw materials.

N A T U R A L M A T E R I A L S

L O O K - F E E L - S M E L L



# S Q U A R E L F S

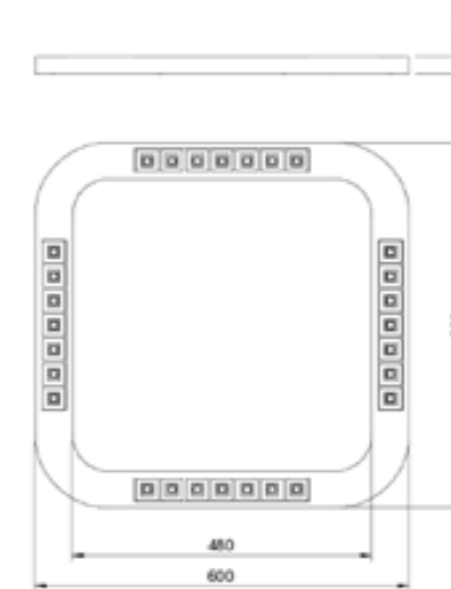
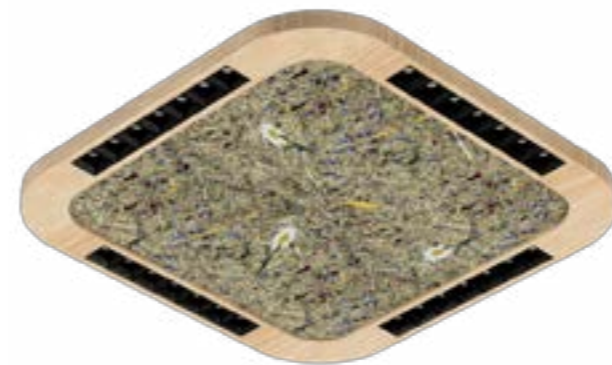

## PRODUCT DATA

**Size :** 600 x 600 x 28 mm  
**Weight :** 3,2 kg  
**Materials :** Housing : Natural solid wood  
 Optic: Polycarbonate lens + reflector  
 Base plate: Aluminium  
**Optic :** Dark Light Reflector 80 °  
**Light distribution :** Direct  
**Driver :** FIX, DALI, Bluetooth (inside or on ceiling)  
**Ambient temperature :** 0 / + 35 °C  
**Lifetime :** L80B10 - 60 000 hours  
**Installation :** suspended

## WOOD SQUARE LED 60 -600 LFS



### WOOD OPTIONS

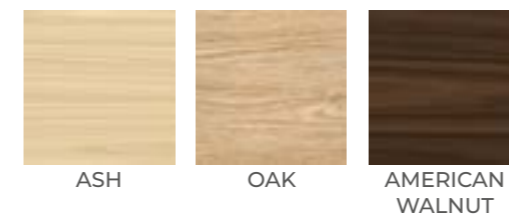

## TECHNICAL SPECIFICATION

CODE	POWER	CRI	CCT	LUMEN
WS60-600LFS	27 W	> 90	3000 K	3480 lm
WS60-600LFS	27 W	> 90	4000 K	3630 lm
WS60-600LFS	28 W	> 90	TW (2700 - 6500 K)	3480 lm

### Order example:

WS60-600LFS	-	Power	-	CRI / CCT	-	Beam	-	Wood	-	Driver	-	Option
WS60-600LFS	-	27	-	930	-	80	-	OAK	-	FIX	-	HAYMIX



# T W I N R O U N D L F S

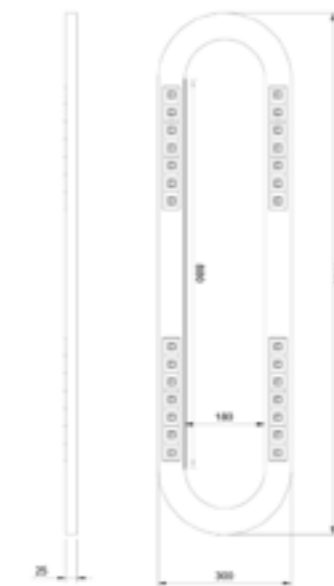

## PRODUCT DATA

**Size :** 300 x 1180 x 25 mm  
**Weight :** 3,8 kg  
**Materials :** Housing : Natural solid wood  
 Optic: Polycarbonate  
 Base plate: Aluminium  
**Optic :** Dark Light Reflector 80 °  
**Light distribution :** Direct  
**Driver :** FIX, DALI, Bluetooth (inside or on ceiling)  
**Ambient temperature :** 0 / + 35 °C  
**Lifetime :** L80B10 - 60 000 hours  
**Installation :** suspended

## WOOD LINEAR LED 60 TWIN ROUND LFS



### WOOD OPTIONS

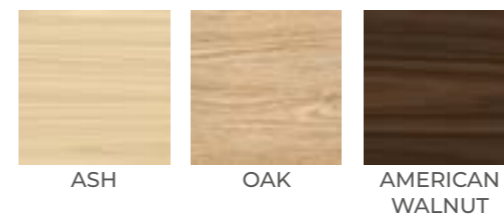

## TECHNICAL SPECIFICATION

CODE	POWER	CRI	CCT	LUMEN
WL60TRLFS	27 W	> 90	3000 K	3480 lm
WL60TRLFS	27 W	> 90	4000 K	3630 lm
WL60TRLFS	28 W	> 90	TW (2700 - 6500 K)	3480 lm

### Order example:

WL60TRLFS	-	Power	-	CRI / CCT	-	Beam	-	Wood	-	Driver	-	Option
WL60TRLFS	-	27	-	930	-	80	-	OAK	-	FIX	-	Almwiesn





# R I N G L F S

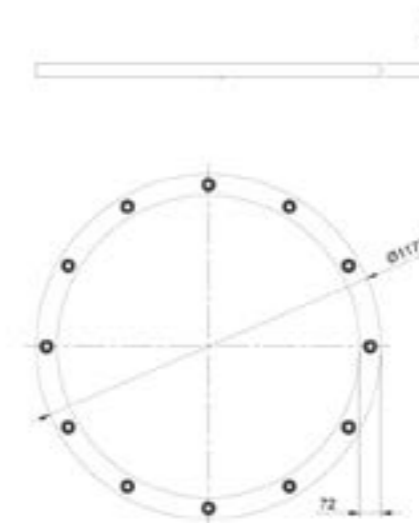

## PRODUCT DATA

**Size :** 1173 x 1173 x 45 mm  
**Weight :** 11,2 kg  
**Materials :** Housing : Natural solid wood  
 Optic: Polycarbonate  
 Base plate: Aluminium  
**Optic :** Lens 36°, 60° and milled light chambers  
**Light distribution :** Direct  
**Driver :** FIX, DALI, Bluetooth ( inside ceiling )  
**Ambient temperature :** 0 / + 35 °C  
**Lifetime :** L80B10 - 60 000 hours  
**Installation :** suspended

## WOOD RING LED 70 - 1200 LFS



### WOOD OPTIONS

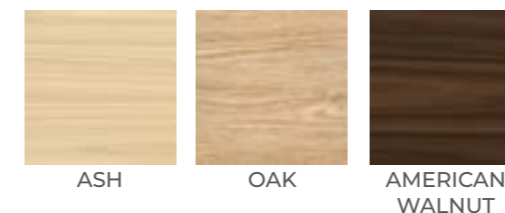

## TECHNICAL SPECIFICATION

CODE	POWER	CRI	CCT	LUMEN
WRI70-1200LFS	70 W	> 90	3000 K	7800 lm
WRI70-1200LFS	70 W	> 90	4000 K	8000 lm

### Order example:

WRI70-1200LFS	-	Power	-	CRI / CCT	-	Beam	-	Wood	-	Driver	-	Option
WRI70-1200LFS	-	70	-	930	-	60	-	OAK	-	FIX	-	Moss hellgr



# D O N U T L F S

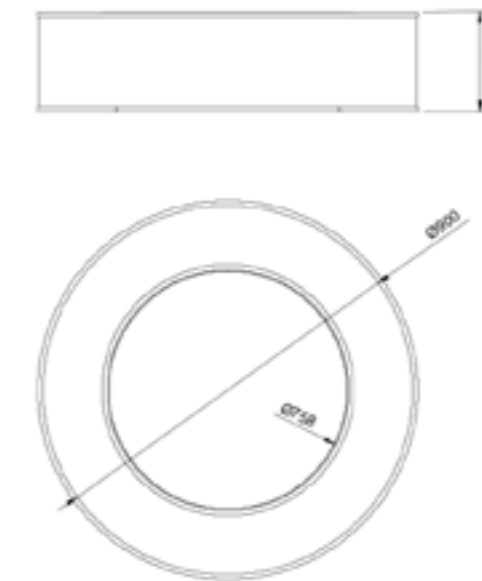

## PRODUCT DATA

**Size :** 900 x 900 x 250 mm  
**Weight :** 7,6 kg  
**Materials :** Housing : Natural solid wood frame, decor  
 Optic: PMMA  
 Base plate: Aluminium  
**Optic :** Diffusor  
**Light distribution :** lambertian  
**Driver :** FIX, DALI, Bluetooth (build in)  
**Ambient temperature :** 0 / + 35 °C  
**Lifetime :** L80B10 - 60 000 hours  
**Installation :** suspended

## DONUT LED 900 x 250 LFS



### WOOD OPTIONS

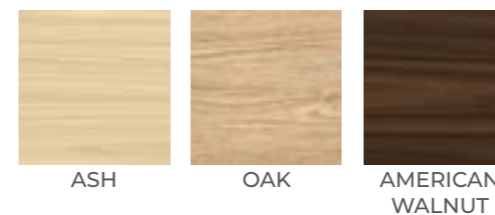

## TECHNICAL SPECIFICATION

CODE	POWER	CRI	CCT	LUMEN
DON900LFS	76 W	> 90	3000 K	6000 lm
DON900LFS	76 W	> 90	4000 K	6450 lm
DON900LFS	76 W	> 90	TW (2700 - 6500 K)	6000 lm

### Order example:

DON900LFS	-	Power	-	CRI / CCT	-	Beam	-	Wood	-	Driver	-	Option
DON900LFS	-	76	-	930	-	DIFF	-	OAK	-	FIX	-	HAYMIX





# W O O D P E N D A N T S



## WOOD BALL LED

Handmade solid wood luminaire in ball shape with direct illumination and various beam angles from 12-60° powered by high precision lenses. The integrated chrysal heatsink provide through chimney effect best thermal management aspects.

Surface threathments: Natural, oiled, antibacterial coating with silver nano-particles (flame retardant according to DIN 4102 B1)



## WOOD CONE LED

Handmade solid wood luminaire in conical shape with direct illumination and various beam angles from 12-60° powered by high precision lenses. The integrated chrysal heatsink provide through chimney effect best thermal management aspects.

Surface threathments: Natural, oiled, antibacterial coating with silver nano-particles (flame retardant according to DIN 4102 B1)



## WOOD CYLINDER LED

Handmade solid wood luminaire in cylindric shape with direct illumination and various beam angles from 12-60° powered by high precision lenses. The integrated chrysal heatsink provide through chimney effect best thermal management aspects.

Surface threathments: Natural, oiled, antibacterial coating with silver nano-particles (flame retardant according to DIN 4102 B1)





# B A L L

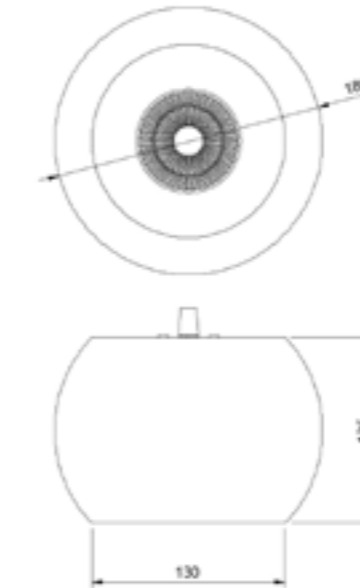

## PRODUCT DATA

**Size :** 180 x 180 x 125  
**Weight :** 1,7 kg  
**Materials :** Housing : Natural solid wood  
 Optic: Polycarbonate  
 Base plate: Aluminium  
**Optic :** Lens 12 °, 24 °, 38 °, 60 °  
**Light distribution :** Direct  
**Driver :** FIX, DALI, Bluetooth (inside or on ceiling)  
**Ambient temperature :** 0 / + 35 °C  
**Lifetime :** L80B10 - 60 000 hours  
**Installation :** suspended

## WOOD BALL LED

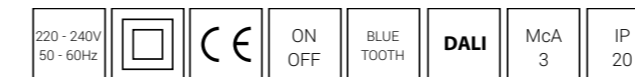

## WOOD OPTIONS

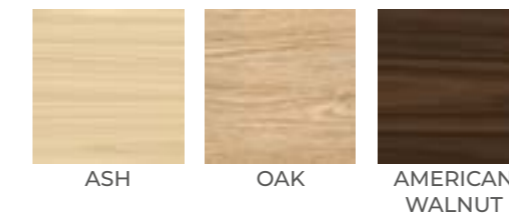

## TECHNICAL SPECIFICATION

CODE	POWER	CRI	CCT	LUMEN
WB	12 W	> 90	2700 K	975 lm
WB	12 W	> 90	3000 K	1050 lm
WB	12 W	> 95	3200 K	975 lm
WB	12 W	> 90	4000 K	1150 lm

## Order example:

WB	-	Power	-	CRI / CCT	-	Beam	-	Wood	-	Driver	-	Option
WB	-	12	-	930	-	60	-	OAK	-	FIX	-	XYZ



C O N E

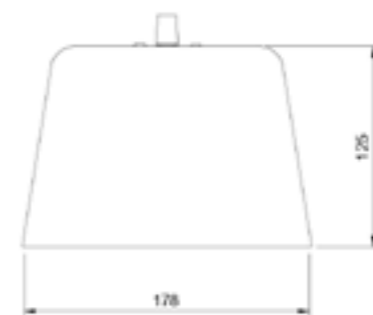

## PRODUCT DATA

Size : 178 x 178 x 125 mm  
 Weight : 1,3 kg  
 Materials : Housing : Natural solid wood  
 Reflector: Polycarbonate  
 Base plate: Aluminium  
 Optic : Lens 12 °, 24 °, 38 °, 60 °  
 Light distribution : Direct  
 Driver : FIX, DALI, Bluetooth (inside or on ceiling)  
 Ambient temperature : 0 / + 35 °C  
 Lifetime : L80B10 - 60 000 hours  
 Installation : suspended

## WOOD CONE LED



## WOOD OPTIONS

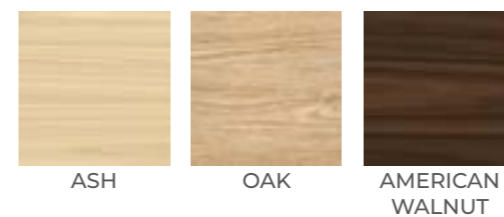

## TECHNICAL SPECIFICATION

CODE	POWER	CRI	CCT	LUMEN
WCO	12 W	> 90	2700 K	975 lm
WCO	12 W	> 90	3000 K	1050 lm
WCO	12 W	> 95	3200 K	975 lm
WCO	12 W	> 90	4000 K	1150 lm

Order example:

WCO	-	Power	-	CRI / CCT	-	Beam	-	Wood	-	Driver	-	Option
WCO	-	12	-	930	-	60	-	OAK	-	FIX	-	XYZ



# C Y L I N D E R



## PRODUCT DATA

**Size :** 116 x 116 x 140 mm  
**Weight :** 0,9 kg  
**Materials :** Housing : Natural solid wood  
 Reflector: Polycarbonate  
 Base plate: Alluminium  
**Optic :** Lens 12 °, 24 °, 38 °, 60 °  
**Light distribution :** Direct  
**Driver :** FIX, DALI, Bluetooth (inside or on ceiling)  
**Ambient temperature :** 0 / + 35 °C  
**Lifetime :** L80B10 - 60 000 hours  
**Installation :** suspended

## WOOD CYLINDER LED



### WOOD OPTIONS

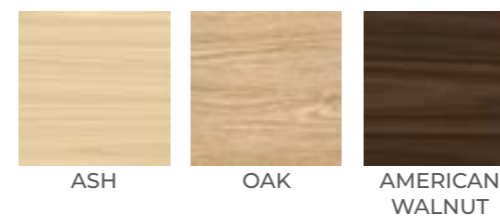

## TECHNICAL SPECIFICATION

CODE	POWER	CRI	CCT	LUMEN
WCY	12 W	> 90	2700 K	975 lm
WCY	12 W	> 90	3000 K	1050 lm
WCY	12 W	> 95	3200 K	975 lm
WCY	12 W	> 90	4000 K	1150 lm

### Order example:

WCY	-	Power	-	CRI / CCT	-	Beam	-	Wood	-	Driver	-	Option
WCY	-	12	-	930	-	60	-	OAK	-	FIX	-	XYZ







S A M P L E S



### WOOD CARDANIC SPOT

Wood Cardanic Spot is a cardanic downlight based on shielded lens technology. The thermal management is solved by a high performance pressed aluminium heatsink which performs 40% better than traditional thermal solutions. Beam angles from 12-60° make this luminaire with solid wood frame an allrounder for many applications.

Surface threathments: Natural, oiled, antibacterial coating with silver nanoparticles (flame retardant according to DIN 4102 B1)



### WOOD CARDANIC TWIN SPOT

Wood Cardanic Twn Spot is a cardanic downlight based on shielded lens technology and 2 luminaire heads. The thermal management is solved by a high performance pressed aluminium heatsink which performs 40% better than traditional thermal solutions. Beam angles from 12-60° make this luminaire with solid wood frame an allrounder for many applications.

Surface threathments: Natural, oiled, antibacterial coating with silver nanoparticles (flame retardant according to DIN 4102 B1)



### WOOD LINEAR DOWNLIGHT 190

Wood Linear 190 is a compact downlight wiht dark light reflectors. The lenght can be customized.

Surface threathments: Natural, oiled, antibacterial coating with silver nanoparticles (flame retardant according to DIN 4102 B1)





# C A R D A N I C



## WOOD CARDANIC SPOT

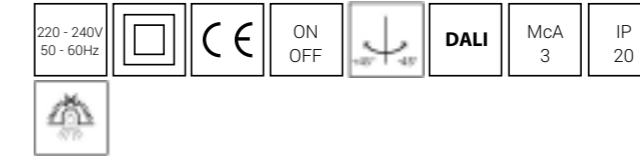

### WOOD OPTIONS

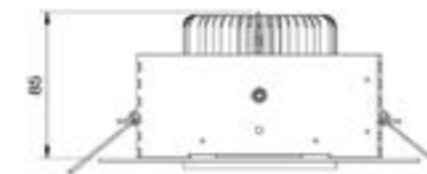
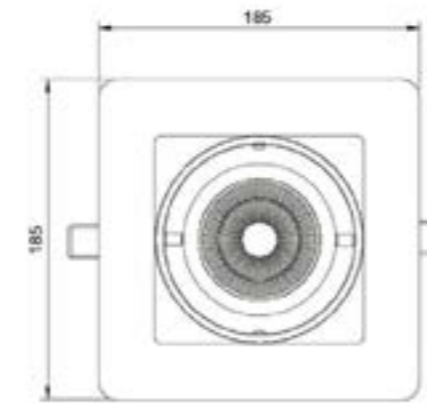
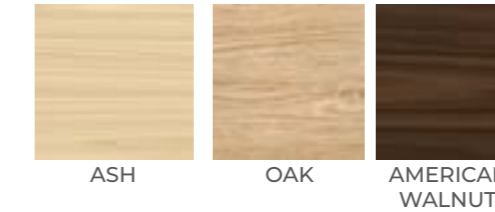

## PRODUCT DATA

**Size :** 185 x 185 x 85 mm  
**Weight :** 1,2 kg  
**Materials :** Frame : Natural solid wood  
 Reflector: Polycarbonate  
 Luminaire head: Aluminium  
 Housing: Metal  
**Optic :** Shielded lens 12°, 24°, 38°, 55°  
**Light distribution :** Direct  
**Driver :** FIX, DALI, Bluetooth (inside ceiling)  
**Ambient temperature :** 0 / + 35 °C  
**Lifetime :** L80B10 - 60 000 hours  
**Installation :** ceiling recessed (cut out 165 x 165 mm)

## TECHNICAL SPECIFICATION

CODE	POWER	CRI	CCT	LUMEN
WCS	16 W	> 90	2700 K	1300 lm
WCS	16 W	> 90	3000 K	1400 lm
WCS	16 W	> 95	3200 K	1300 lm
WCS	16 W	> 90	4000 K	1600 lm
WCS	28 W	> 95	2700 K	2200 lm
WCS	28 W	> 90	3000 K	2400 lm
WCS	28 W	> 95	3200 K	2200 lm
WCS	28 W	> 90	4000 K	2700 lm

### Order example:

WCS	-	Power	-	CRI / CCT	-	Beam	-	Wood	-	Driver	-	Option
WCS	-	16	-	930	-	55	-	OAK	-	FIX	-	XYZ



# C A R D A N I C T W I N



## WOOD CARDANIC TWIN SPOT

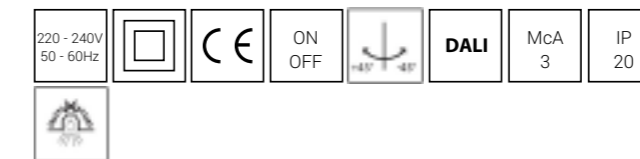

### WOOD OPTIONS



## PRODUCT DATA

Size : 360 x 185 x 65 mm  
 Weight : 2,4 kg  
 Materials : Frame : Natural solid wood  
 Optic: Polycarbonate  
 Luminaire head: Aluminium  
 Optic : Shielded lens 12°, 24°, 38°, 55°  
 Light distribution : Direct  
 Driver : FIX, DALI, Bluetooth (inside ceiling)  
 Ambient temperature : 0 / + 35 °C  
 Lifetime : L80B10 - 60 000 hours  
 Installation : ceiling recessed (cut out 340 x 165 mm)

## TECHNICAL SPECIFICATION

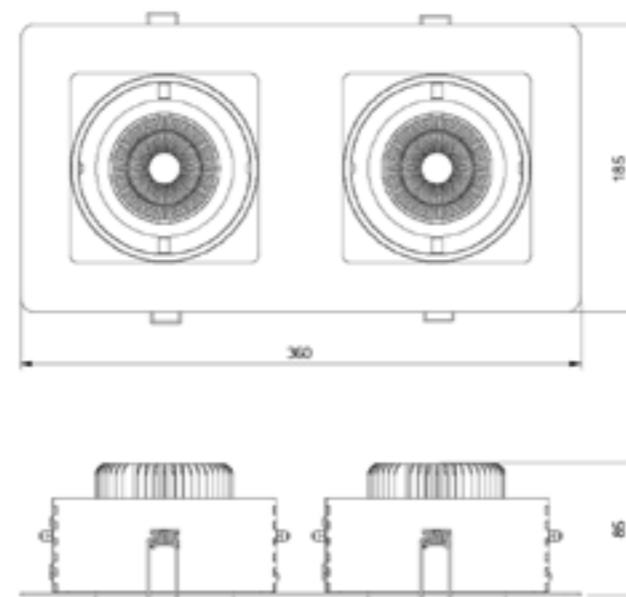

CODE	POWER	CRI	CCT	LUMEN
WCTS	2 x 16 W	> 90	2700 K	1300 lm
WCTS	2 x 16 W	> 90	3000 K	1400 lm
WCTS	2 x 16 W	> 95	3200 K	1300 lm
WCTS	2 x 16 W	> 90	4000 K	1600 lm
WCTS	2 x 28 W	> 95	2700 K	2200 lm
WCTS	2 x 28 W	> 90	3000 K	2400 lm
WCTS	2 x 28 W	> 95	3200 K	2200 lm
WCTS	2 x 28 W	> 90	4000 K	2700 lm

Order example:

WCS	-	Power	-	CRI / CCT	-	Beam	-	Wood	-	Driver	-	Option
WCTS	-	16	-	930	-	55	-	OAK	-	FIX	-	XYZ



# LINEAR DOWNLIGHT



## WOOD LINEAR DOWNLIGHT 190

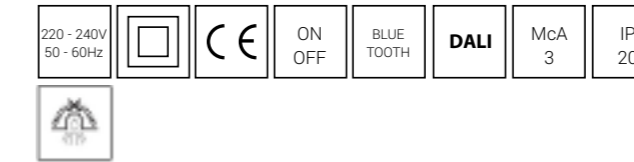

### WOOD OPTIONS

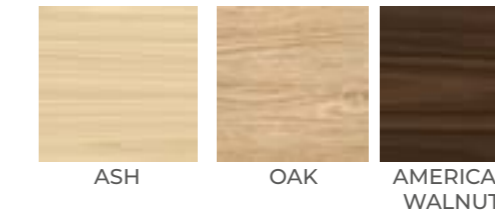

## PRODUCT DATA

**Size :** 199 x 70 x 40 mm  
**Weight :** 0,8 kg  
**Materials :** Frame : Natural solid wood  
 Reflector: Polycarbonate  
 Luminaire head: Aluminium  
**Optic :** Lens 80 °  
**Light distribution :** Direct  
**Driver :** FIX, DALI, Bluetooth (inside ceiling)  
**Ambient temperature :** 0 / + 35 °C  
**Lifetime :** L80B10 - 60 000 hours  
**Installation :** ceiling recessed

## TECHNICAL SPECIFICATION

CODE	POWER	CRI	CCT	LUMEN
WLD190	6 W	> 90	3000 K	660 lm
WLD190	6 W	> 90	4000 K	690 lm
WLD190	6 W	> 90	2700 - 6500 K	630 lm
WLD190	8 W	> 90	3000 K	680 lm
WLD190	8 W	> 95	4000 K	1020 lm

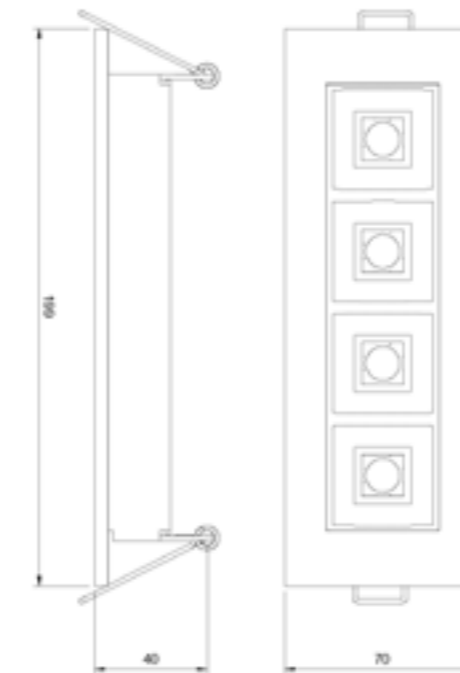

### Order example:

WLD190	-	Power	-	CRI / CCT	-	Beam	-	Wood	-	Driver	-	Option
WLD190	-	6	-	930	-	80	-	OAK	-	FIX	-	XYZ



Avenue du Grand-Champsec 12  
CH-1950 Sion

+41 27 322 94 48  
[info@aluma-light.com](mailto:info@aluma-light.com)  
[www.aluma-light.com](http://www.aluma-light.com)